

1

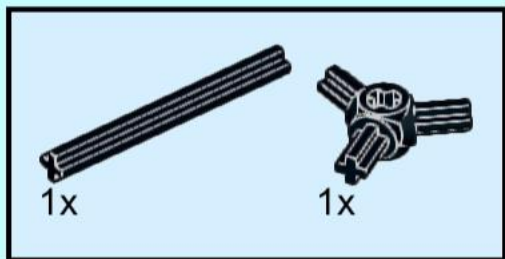

2

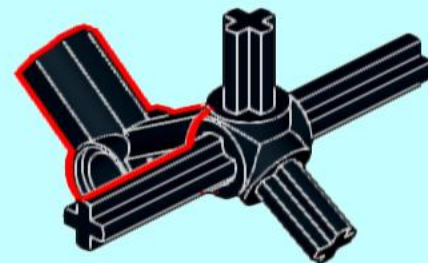
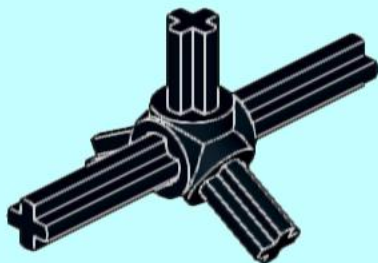

3

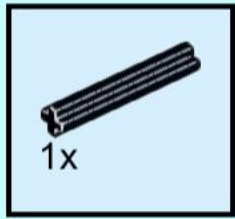

4

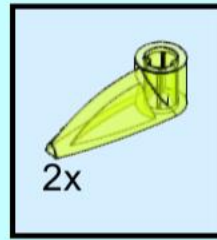

5

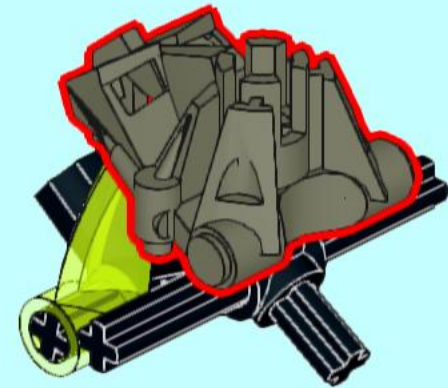
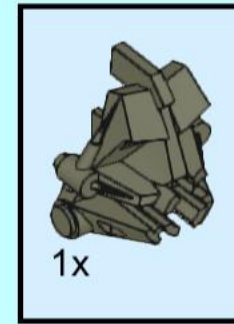

6

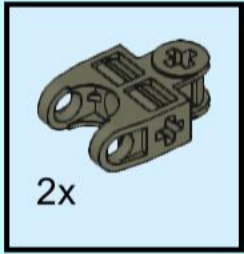

7

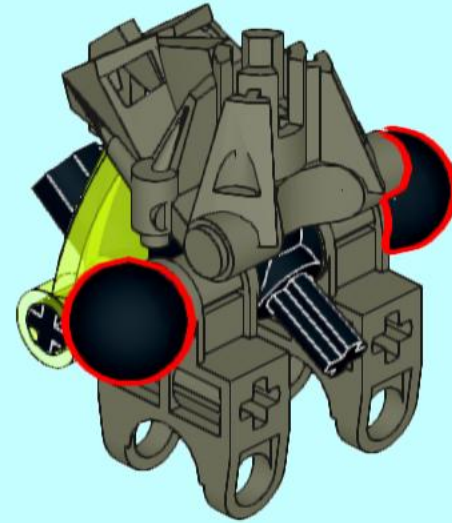
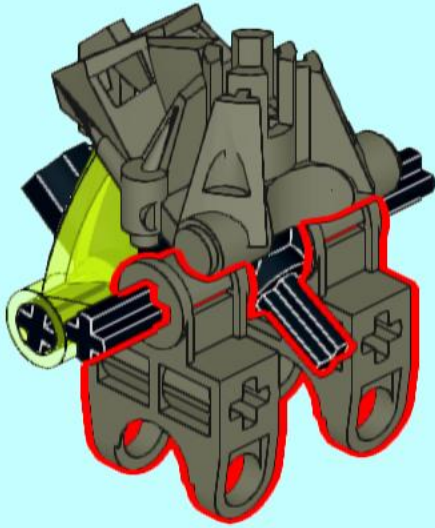

8

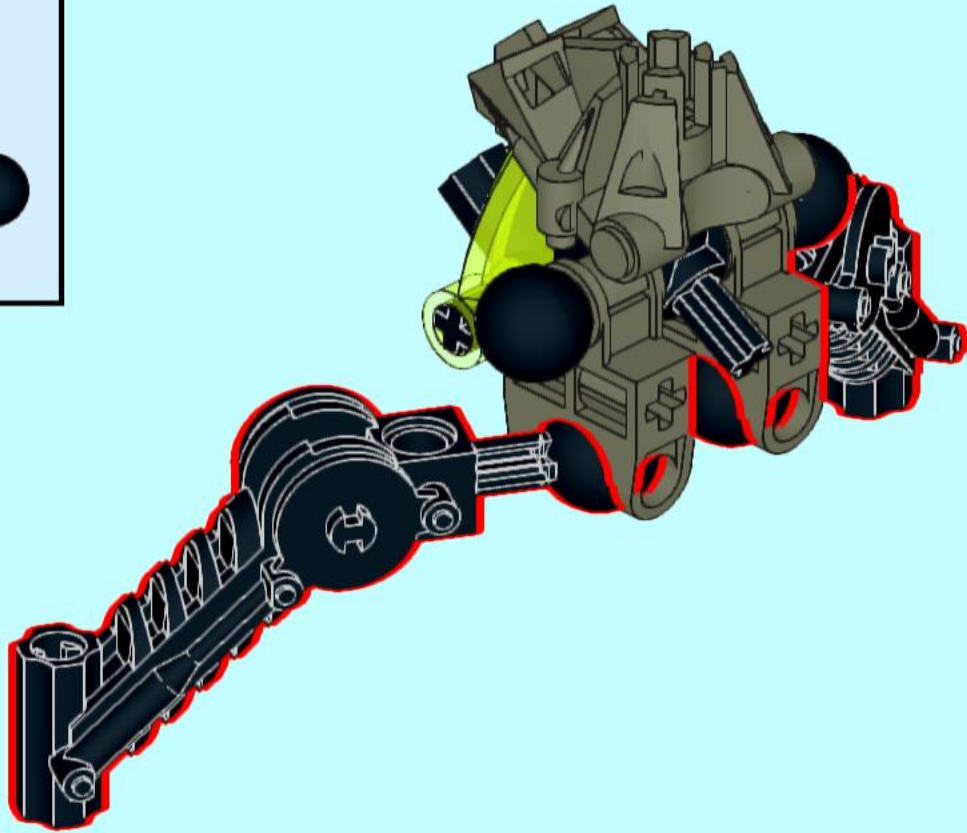
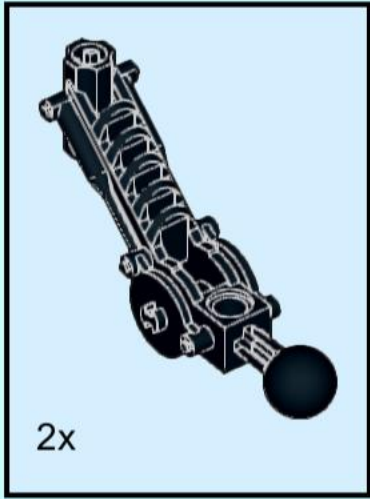

9

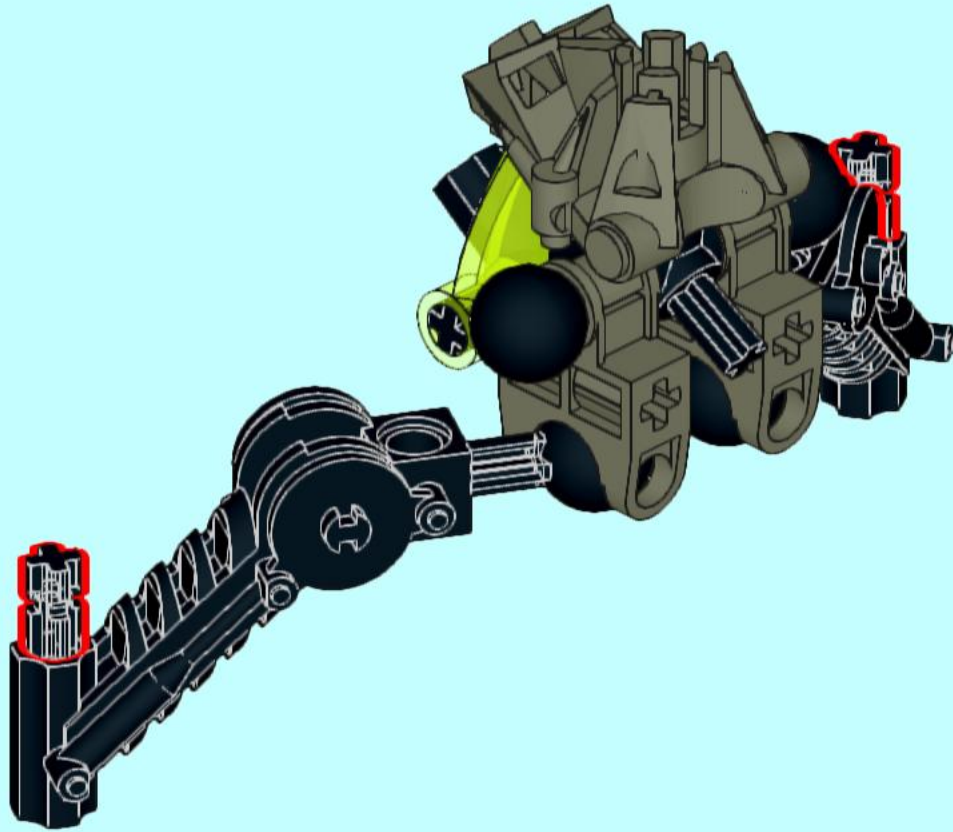

10

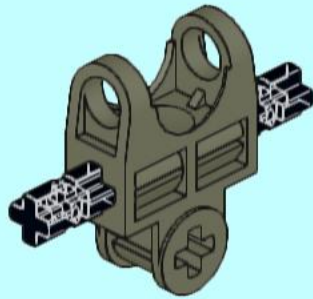
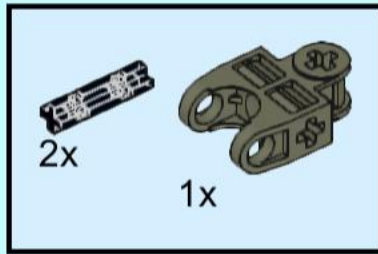

11

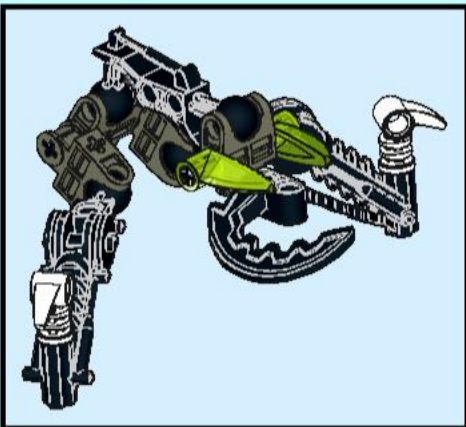
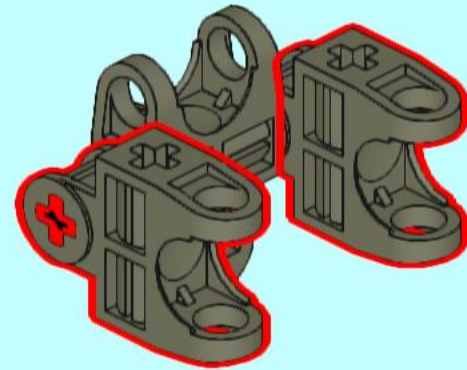
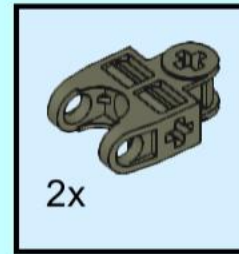

12

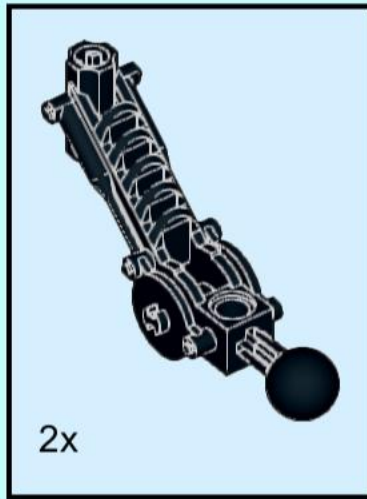

13

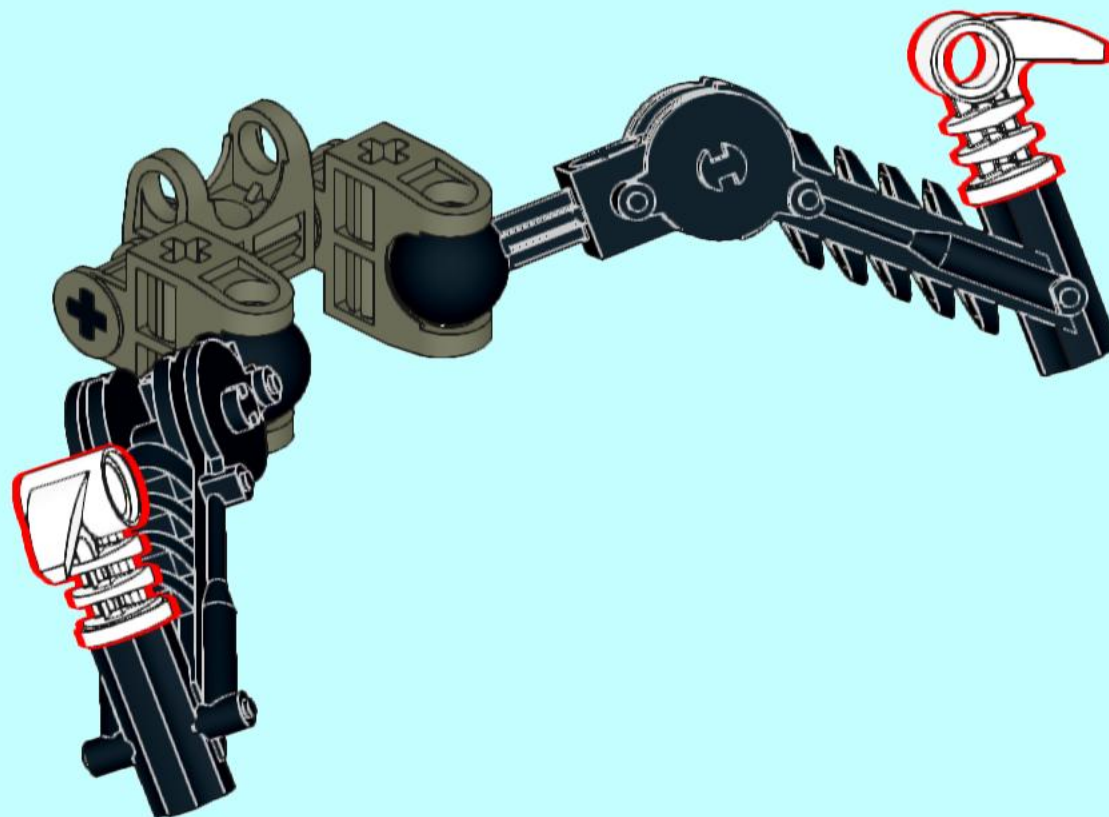
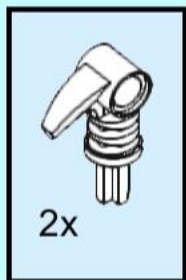

14

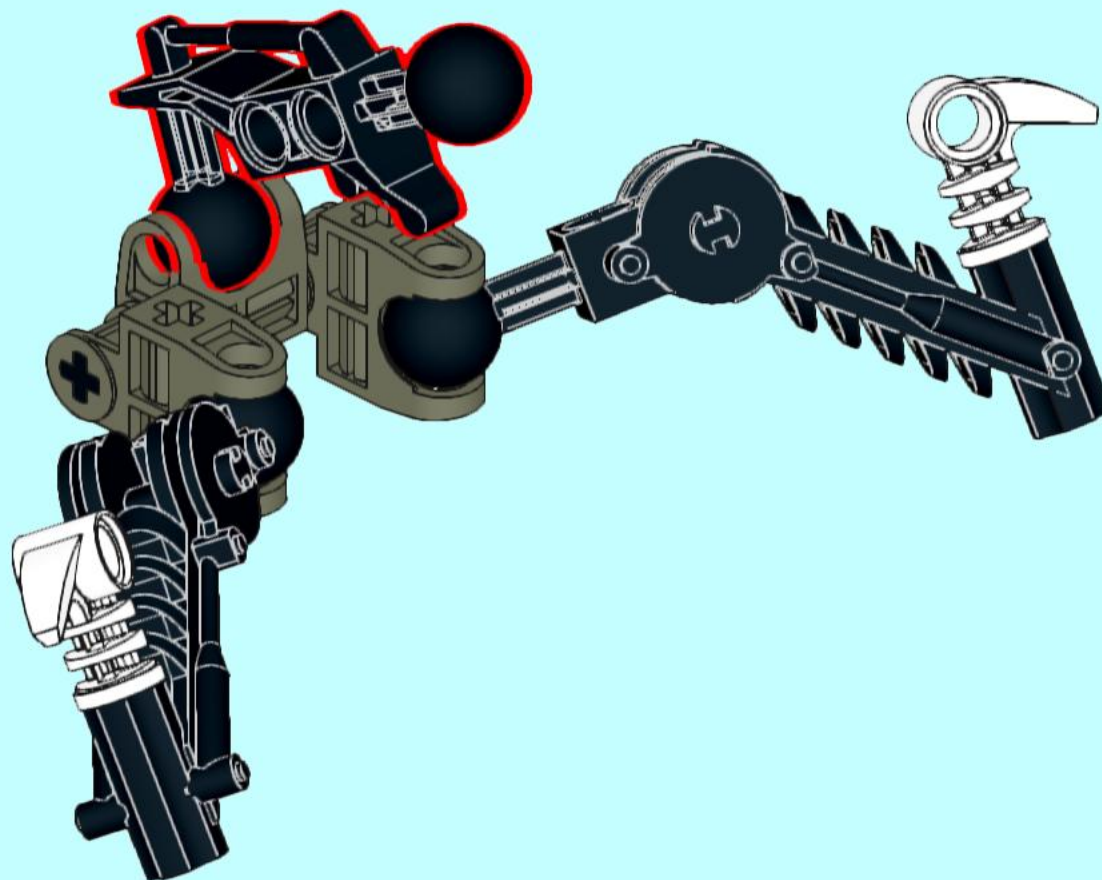

15

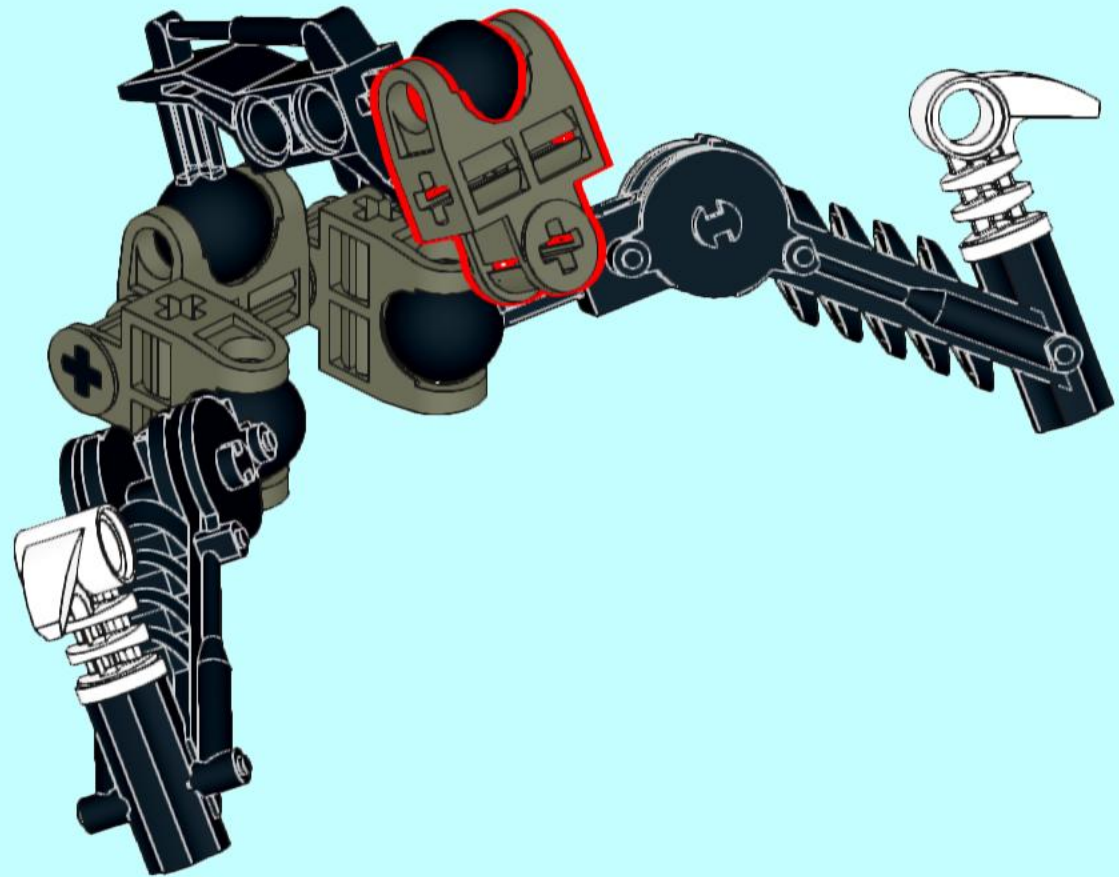
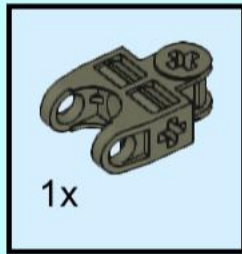

16

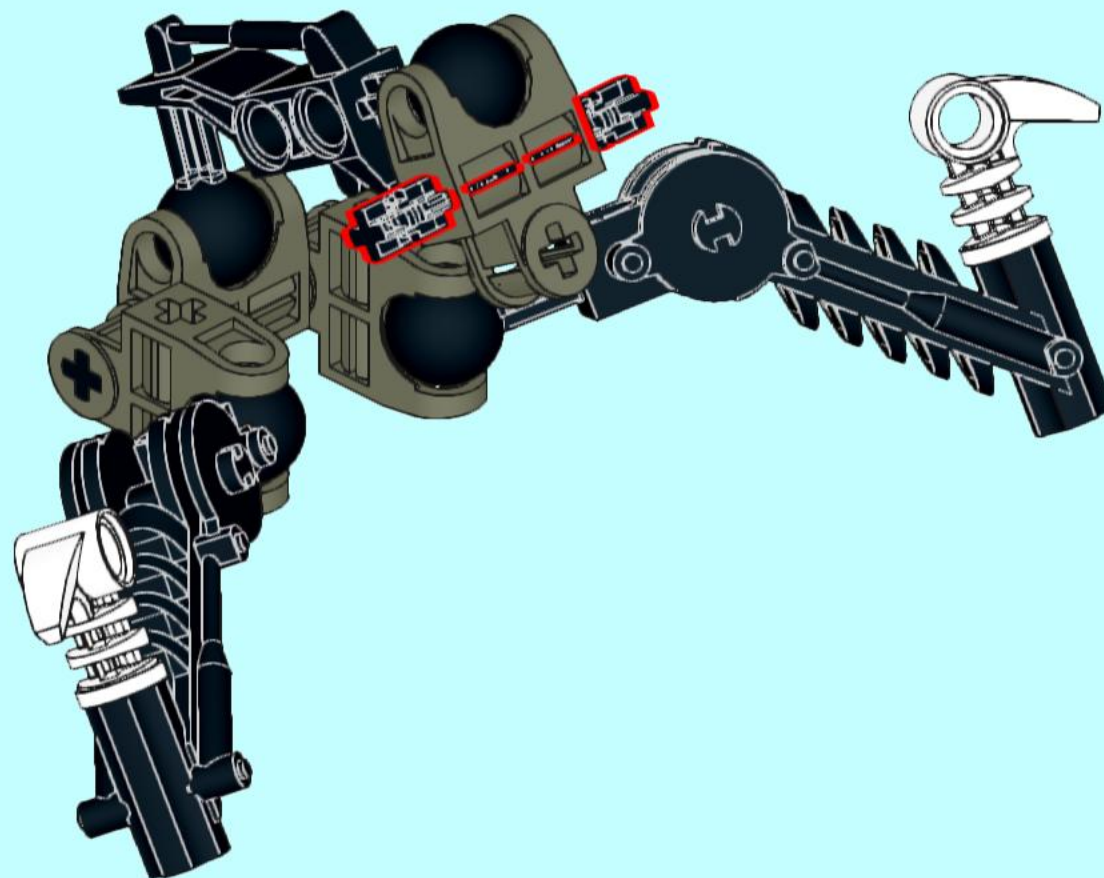

17

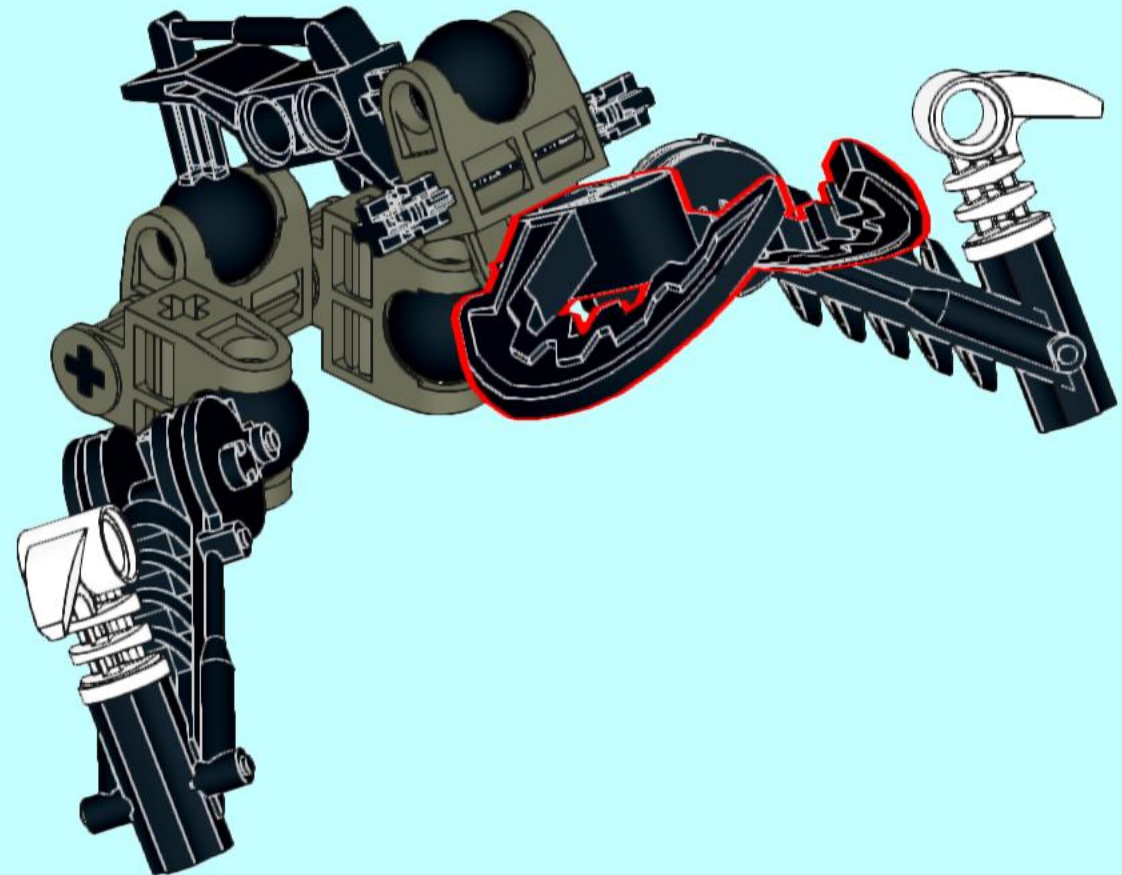
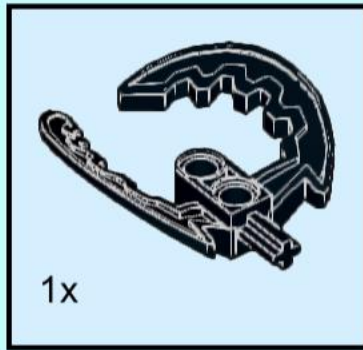

18

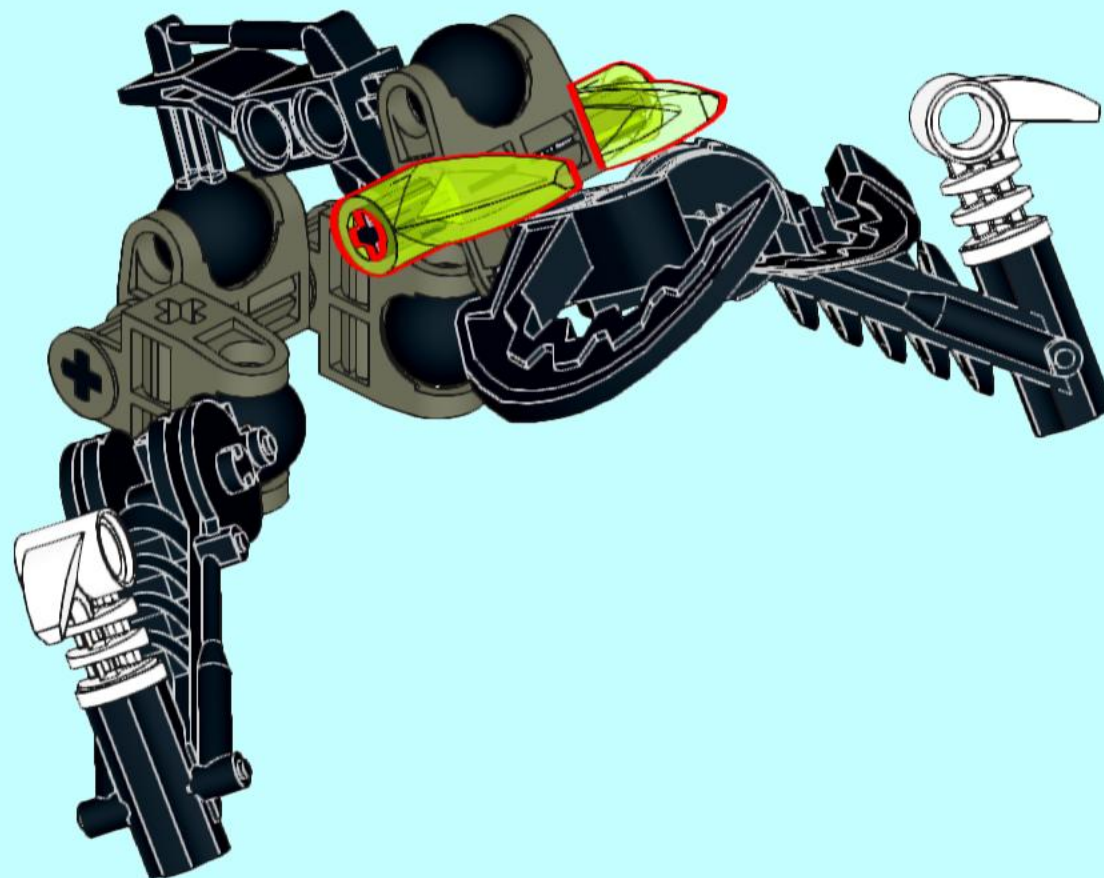
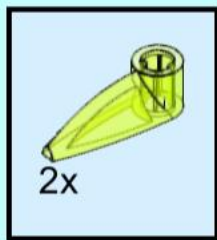

19

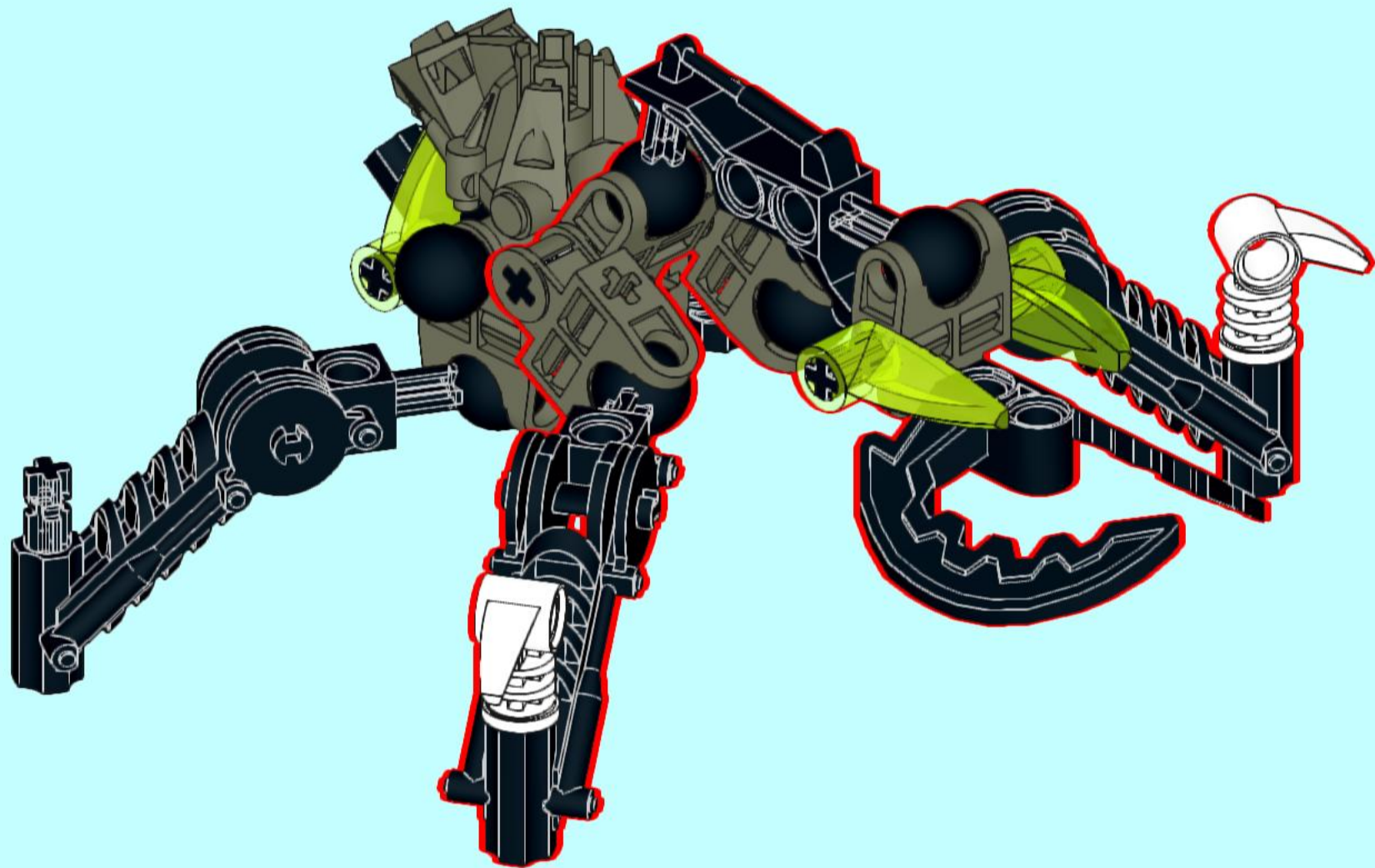

20

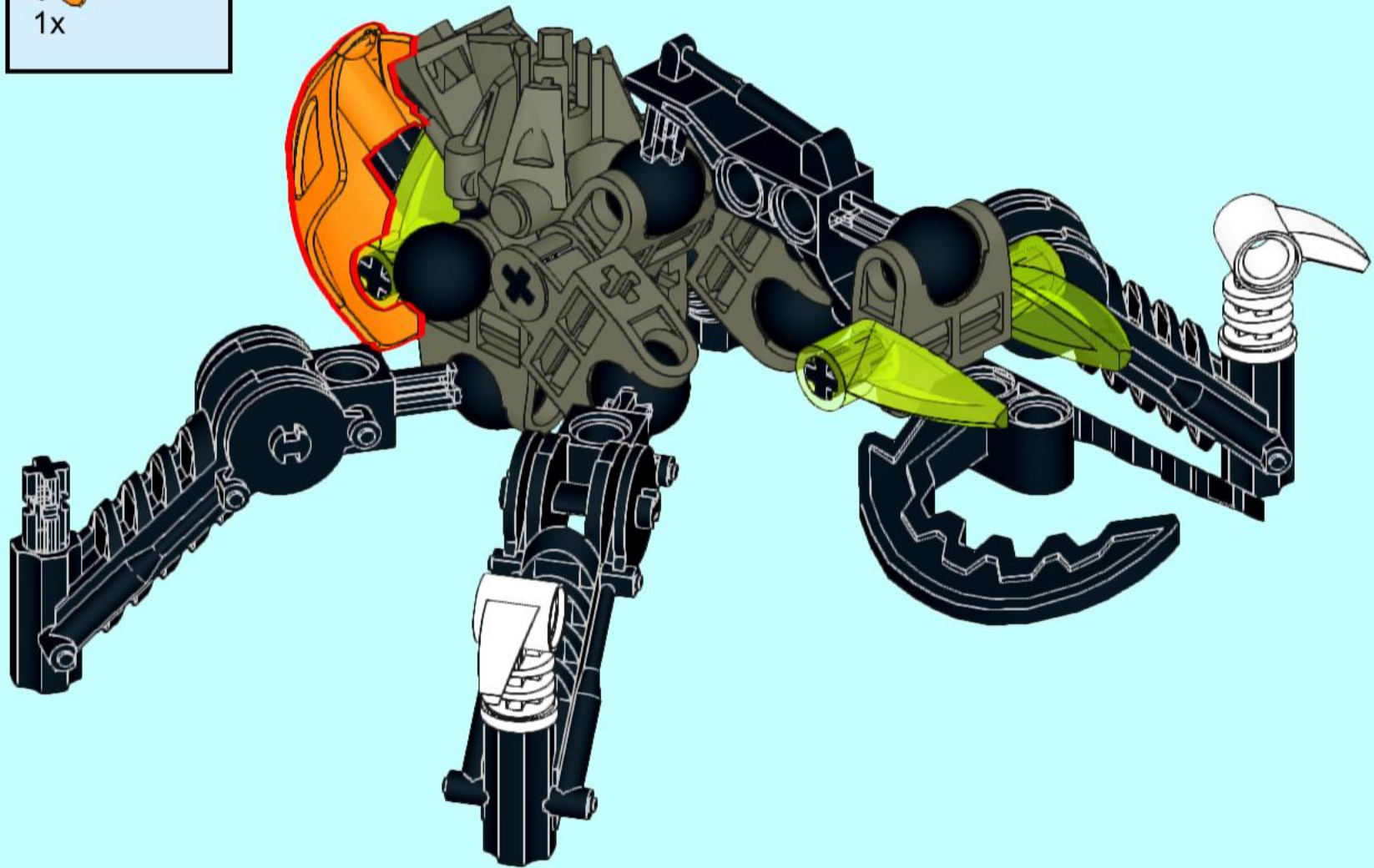
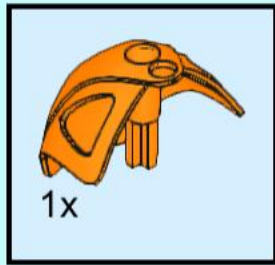

21

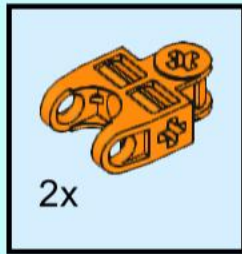

22

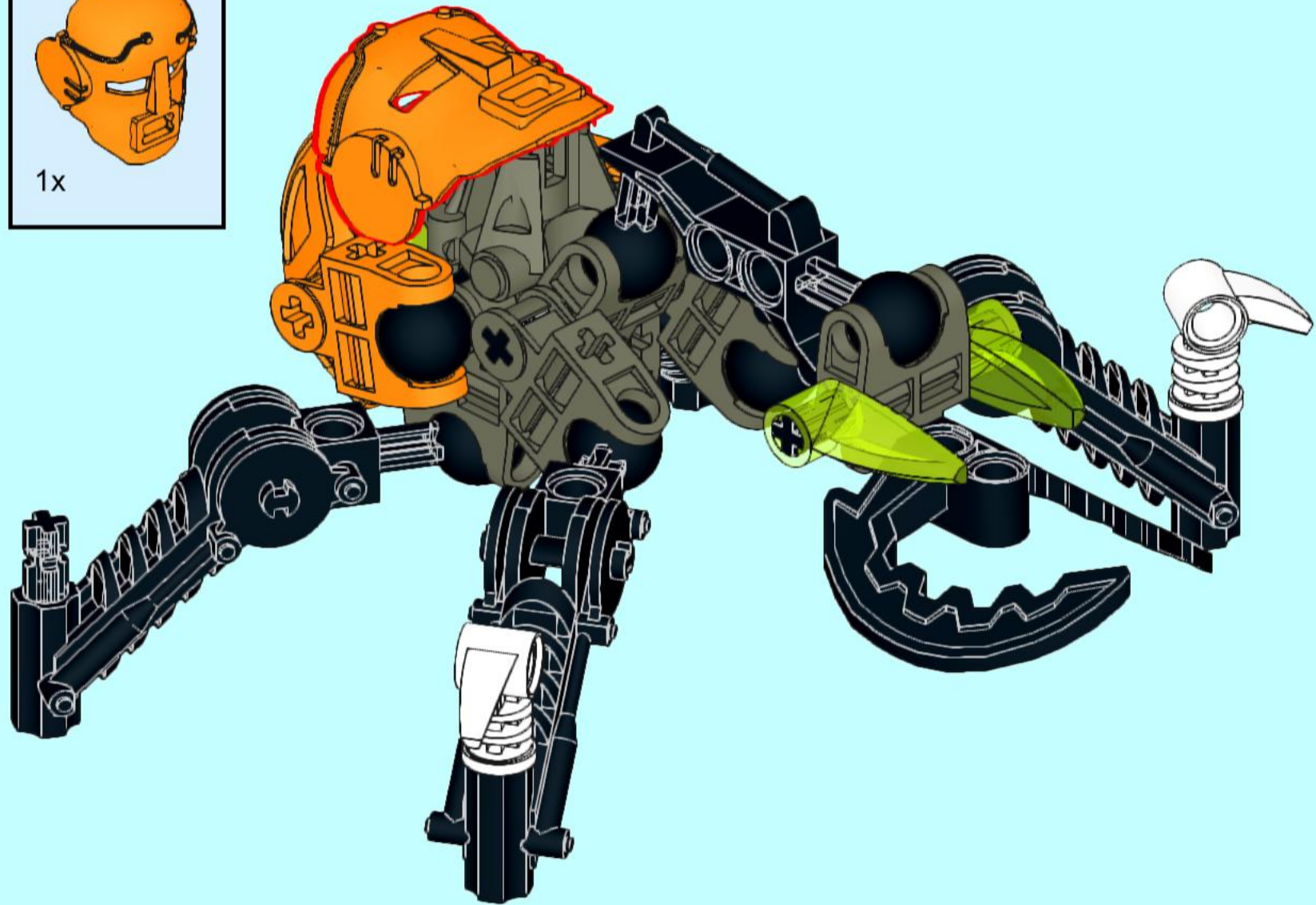
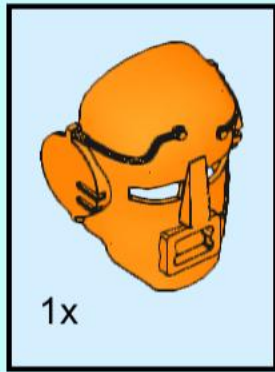



2x
32474
Black



6x
32062
Black

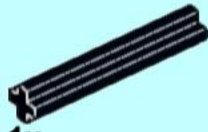

1x
4519
Black



1x
32015
Black



1x
57585
Black

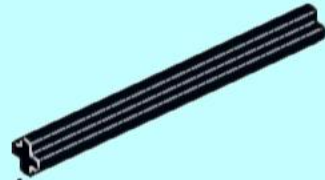

1x
32073
Black

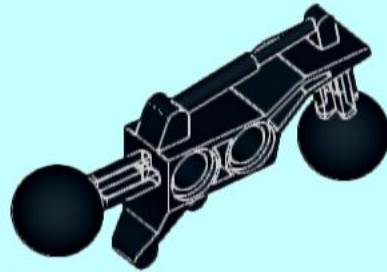

1x
32173
Black

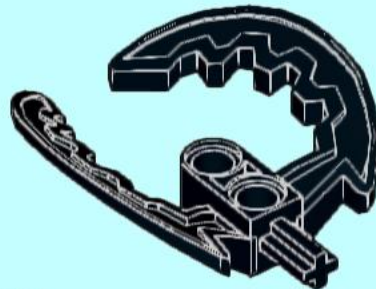

1x
44036
Black



4x
x240
Black



6x
32174
Dark Gray



1x
32553
Dark Gray



2x
42074
White

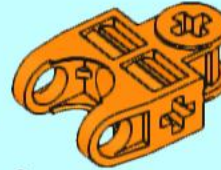

2x
32174
Orange



1x
43559
Orange

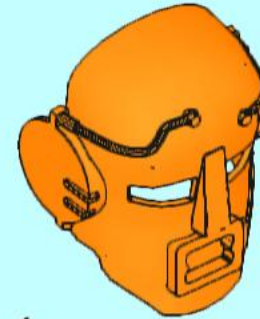

1x
32575
Orange

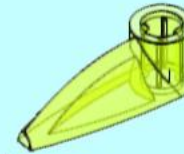

4x
x346
Trans-Neon Green